



Living Base

Adjustable sliding system for wooden/aluminium doors and shutters
Sistema di scorrevoli regolabili per ante in legno o in alluminio



Living Base

Mechanisms for outdoor line panels and internal veneered panels with damped stops.

Meccanismi per ante in linea esterne e ante sovrapposte interne con fermi ammortizzati.







A solution granting functionality and design

Living Base is an hidden sliding system designed for cabinets with wooden or aluminium framed doors. Equipped with air soft-closing dampers, the system is designed in order to be suitable to internal or external doors.

Living Base system combines functionality with design, granting maximal freedom of composition and fulfilling market demand of solution dedicated to "living" spaces.

La soluzione che garantisce funzionalità e design

Living Base è un sistema di scorrevoli regolabili nascosti, per ante in legno o in alluminio, dotato di fermi ammortizzati ad aria, progettato per la realizzazione di ante in linea esterne o interne al vano.













Il sistema **Living Base** unisce funzionalità e design, garantendo massima libertà e rispondendo alle richieste del mercato per soluzioni applicate agli ambienti "living".





Living Base

COMPLETE BOX KIT / KIT COMPLETO IN SCATOLA

K	Complete kit / Kit completo	
	.	
	1221	 Wood - External door Legno - Anta esterna
	1222	 Wood - Internal door Legno - Anta interna
	1223	 Aluminum - External door Alluminio - Anta esterna
	1224	 Aluminum - Internal door Alluminio - Anta interna
	.	
	1	 N.2 Soft damper stoppers N.2 Fermi ammortizzati
	2	 N.2 Soft damper stoppers N.2 Fermi ammortizzati
	3	 N.2 Soft damper stoppers N.2 Fermi ammortizzati
	4	 N.2 Soft damper stoppers - Track height max 30 mm N.2 Fermi ammortizzati - Altezza binario max 30 mm
	5	 N.2 Soft damper stoppers - Track height max 30 mm N.2 Fermi ammortizzati - Altezza binario max 30 mm
	6	 N.2 Soft damper stoppers - Track height max 30 mm N.2 Fermi ammortizzati - Altezza binario max 30 mm
	7	 N.2 Soft damper stoppers - Track height max 25 mm N.2 Fermi ammortizzati - Altezza binario max 25 mm
	8	 N.2 Soft damper stoppers - Track height max 25 mm N.2 Fermi ammortizzati - Altezza binario max 25 mm
	9	 N.2 Soft damper stoppers - Track height max 25 mm N.2 Fermi ammortizzati - Altezza binario max 25 mm
	.	
		01 Anodized Silver / Argento
		16 Anodized Nickel / Nichel

EXAMPLE / ESEMPIO

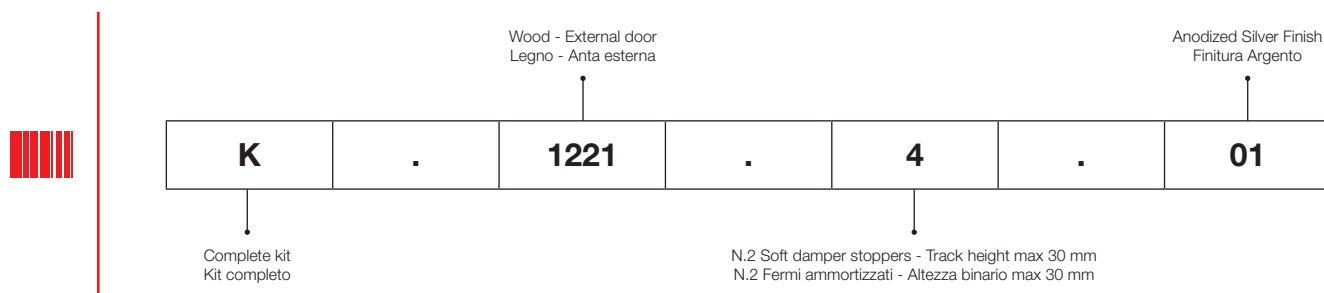

Tracks / Binari

ALUMINUM FINISHES CODES / CODICI FINITURE ALLUMINIO



CODE / CODICE	FINISH COLOR / COLORE FINITURA		STANDARD
8 00 0.0		00 G Raw / Mill Finish / Neutro / Grezzo	
8 01 0.0		01 A Anodized Silver / Argento	
8 02 0.0		02 AS Brushed Anodized Silver / Argento Spazzolato	
8 14 0.0		14 N Anodized Black / Nero	
8 15 0.0		15 NS Brushed Anodized Black / Nero Spazzolato	

Living Base

Adjustable sliding system for wooden/aluminium doors and shutters
Sistema di scorrevoli regolabili per ante in legno o in alluminio

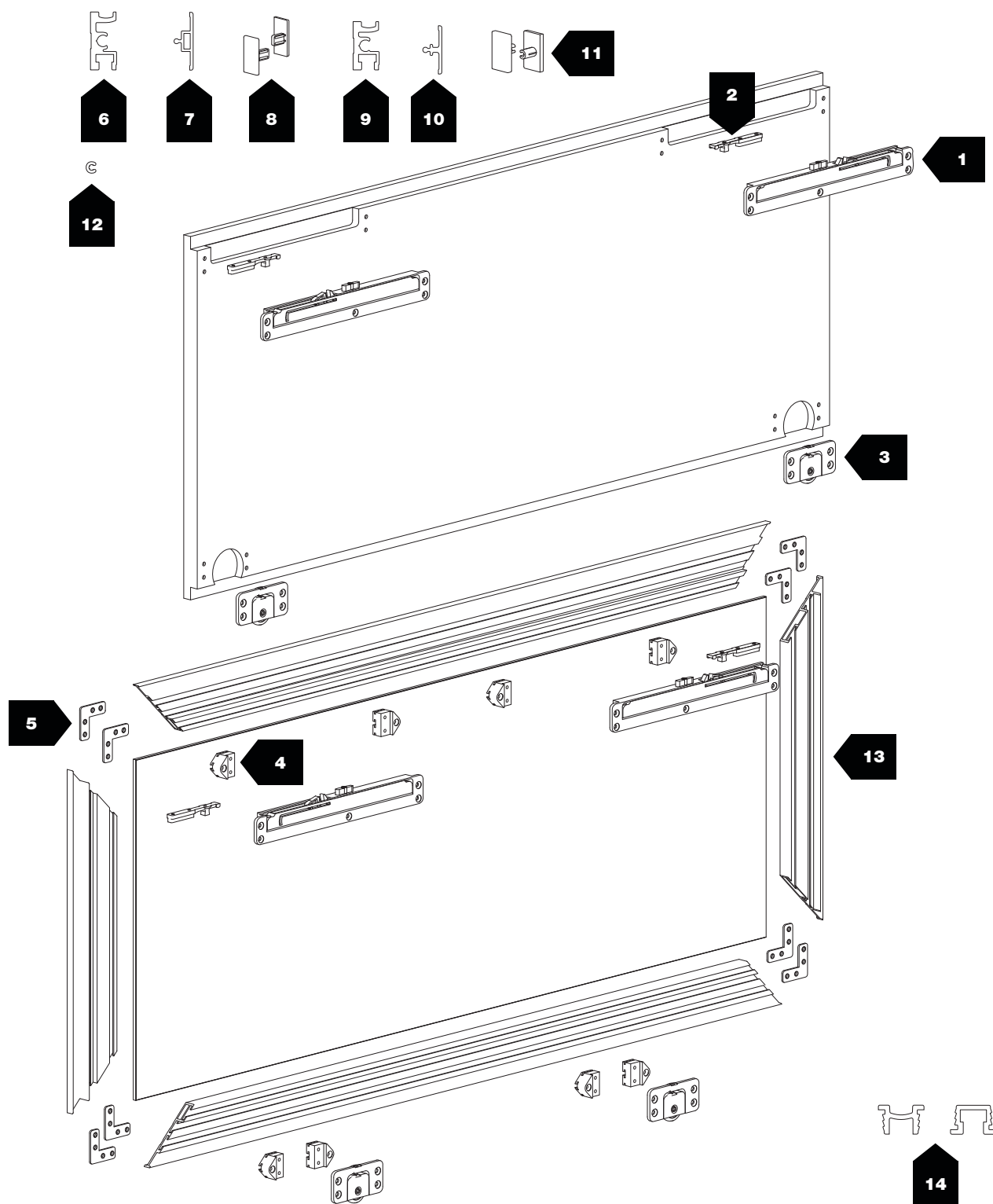









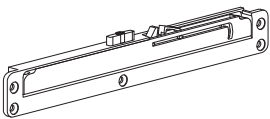

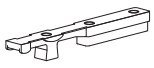

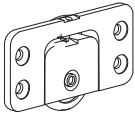
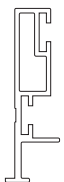
20 ÷ 60 kg

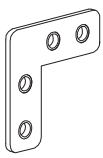
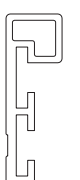
COLORS / COLORI

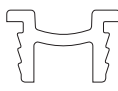
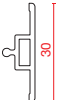
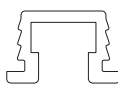
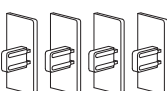
Anodized Silver
Argento

Anodized Nickel
Nichel

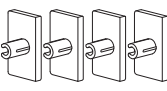
N°	Barcode		kg		N°	Barcode		kg								
1	2143		20		12	1222		20÷60								
	2144		40													
	2149		60													
2	2146		20÷60		13	2152 8 00 0.02152 8 01 0.02152		20÷60								
3	2142		20÷60					2153 8 00 0.02153 8 01 0.02153		20÷60						
4	2151		20÷60							2154 8 00 0.02154 8 01 0.02154		20÷60				
5	384		20÷60									2155 8 00 0.02155 8 01 0.02155		20÷60		
6	2147 8 00 0.02147 8 01 0.02147		20÷60											2080 8 00 0.02080 8 01 0.02080		20÷60
7	2157 8 02 0.02157		20÷60		2090 8 00 0.02090 8 01 0.02090		20÷60									
8	2167		20÷60				14	1943								
9	2145 8 00 0.02145 8 01 0.02145		20÷60													
10	2156 8 02 0.02156		20÷60													
11	2141		20÷60													
												OPTIONAL +				

Living Base

Adjustable sliding system for wooden/aluminium doors and shutters
Sistema di scorrevoli regolabili per ante in legno o in alluminio

 Kit for N.1 door
Kit per N.1 anta

 External door
Anta esterna

 Wooden door
Anta in legno

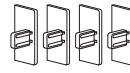
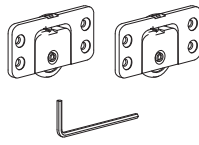
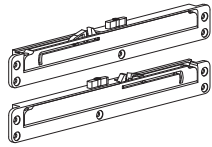

.01 Anodized Silver
Argento



N°16

N°20
3,5x35

N°18
4x20

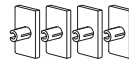
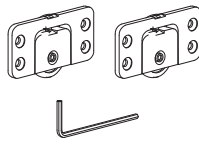
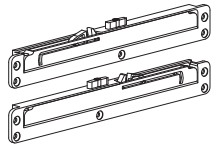

OLD CODE	NEW CODE			
2142/2143/L/A	K.1221.4.01	20 kg	30 mm	10x
2142/2144/L/A	K.1221.5.01	40 kg		10x
2142/2149/L/A	K.1221.6.01	60 kg		10x



N°16

N°20
3,5x35

N°18
4x20

OLD CODE	NEW CODE			
2142/2143/L/25/A	K.1221.7.01	20 kg	25 mm	10x
2142/2144/L/25/A	K.1221.8.01	40 kg		10x
2142/2149/L/25/A	K.1221.9.01	60 kg		10x

MEASUREMENTS DESCRIPTION / DESCRIZIONE MISURE

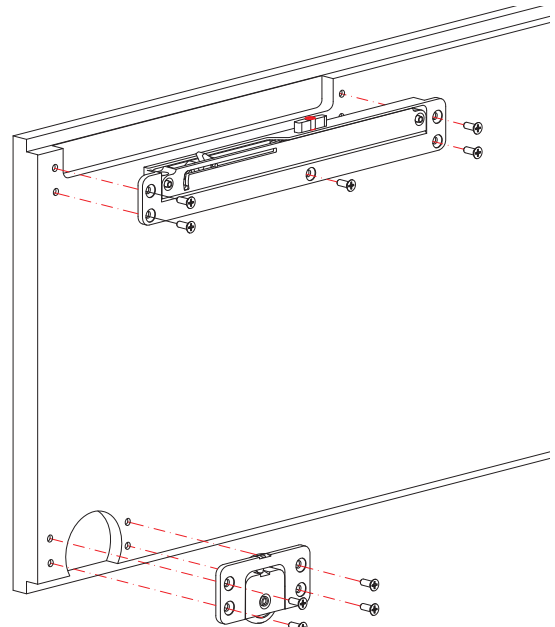
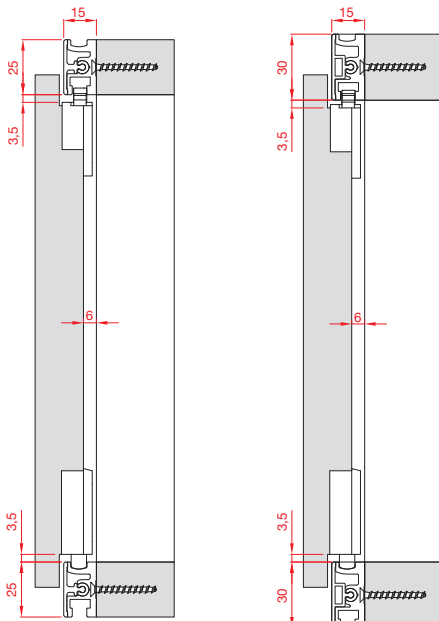
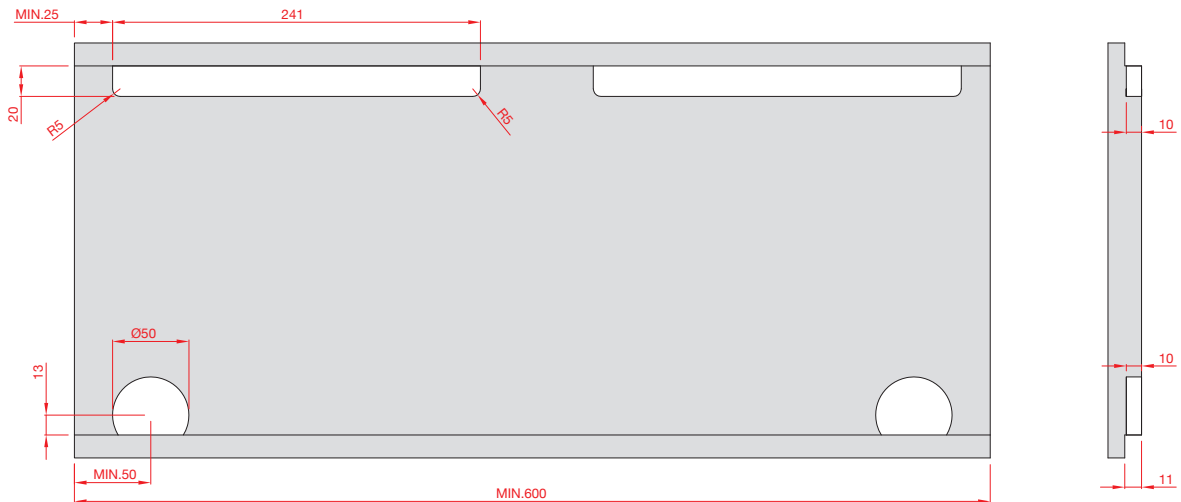

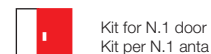
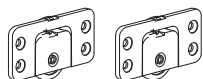
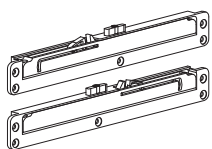

Kit for N.1 door
Kit per N.1 anta





Internal door
Anta interna



Wooden door
Anta in legno



Anodized Nickel
Nichel

OLD CODE	NEW CODE		
2142/2143/L	K.1222.1.16	20 kg	10x
2142/2144/L	K.1222.2.16	40 kg	10x
2142/2149/L	K.1222.3.16	60 kg	10x

MEASUREMENTS DESCRIPTION / DESCRIZIONE MISURE

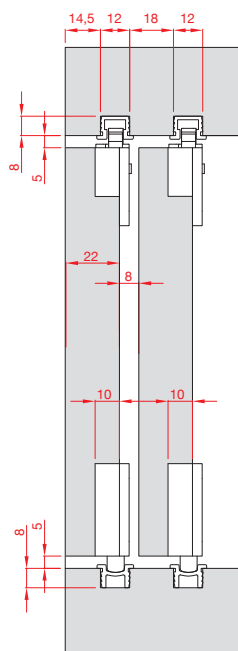
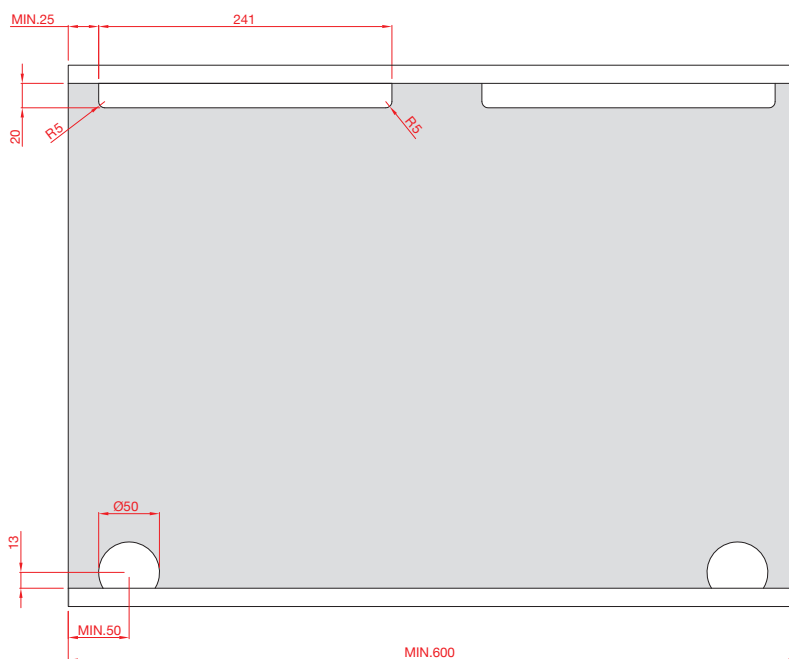
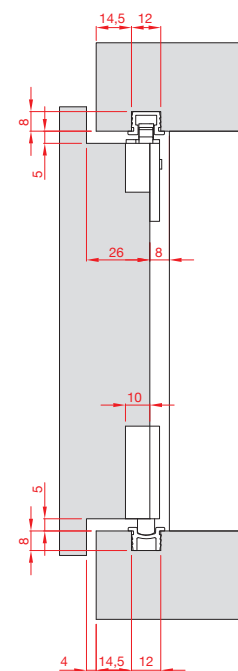
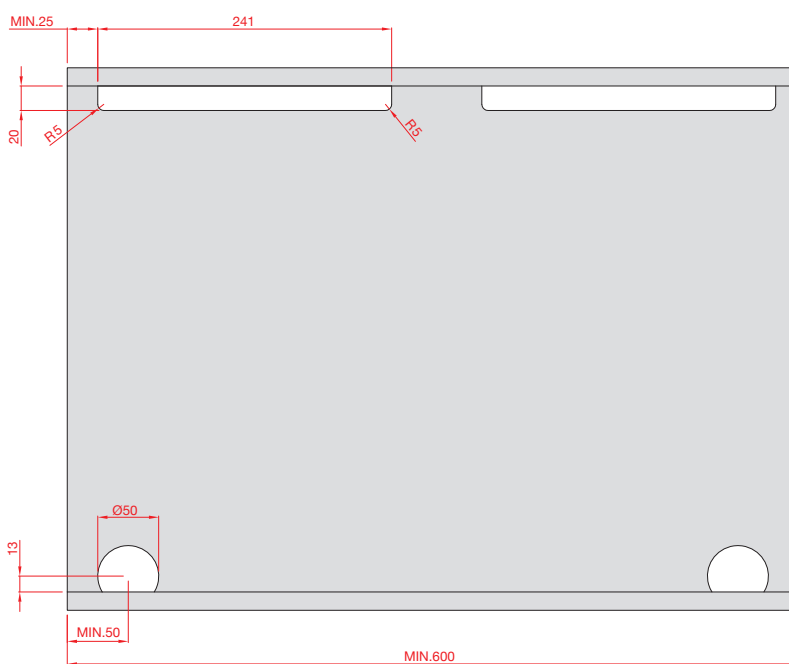

Living Base

Adjustable sliding system for wooden/aluminium doors and shutters
Sistema di scorrevoli regolabili per ante in legno o in alluminio



 Kit for N.1 door
Kit per N.1 anta

 External door
Anta esterna

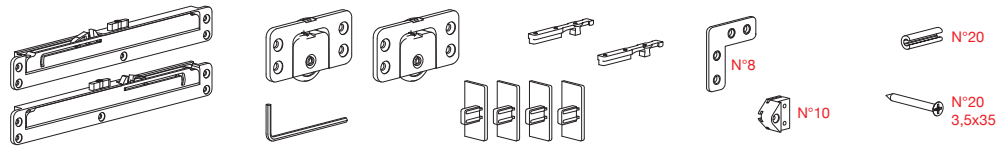

 Aluminium door
Anta in alluminio

.01 Anodized Silver
Argento

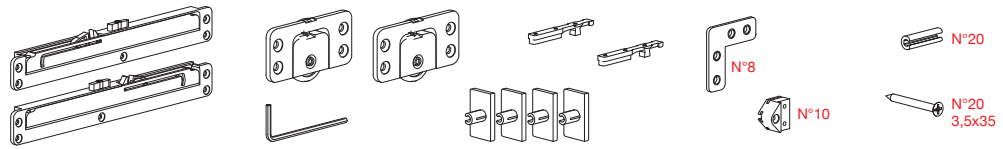

OLD CODE	NEW CODE			
2142/2143/T/A	K.1223.4.01	20 kg	30 mm	10x
2142/2144/T/A	K.1223.5.01	40 kg		10x
2142/2149/T/A	K.1223.6.01	60 kg		10x



OLD CODE	NEW CODE			
2142/2143/T/25/A	K.1223.7.01	20 kg	25 mm	10x
2142/2144/T/25/A	K.1223.8.01	40 kg		10x
2142/2149/T/25/A	K.1223.9.01	60 kg		10x

MEASUREMENTS DESCRIPTION / DESCRIZIONE MISURE

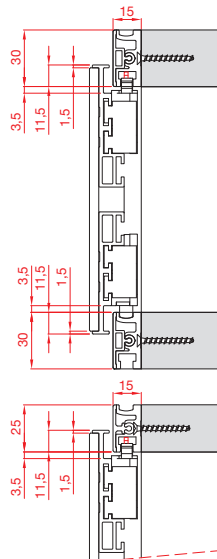
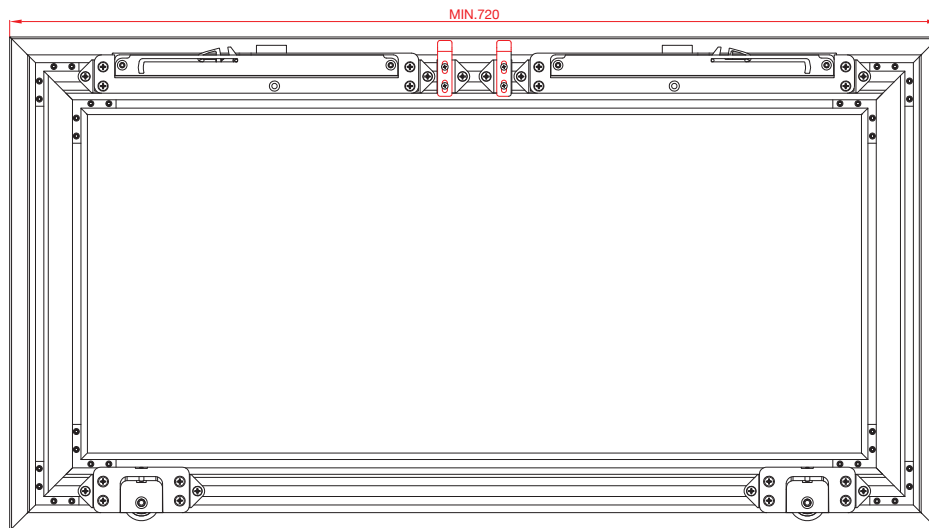

Aluminium door with frame
Anta in alluminio con cornice

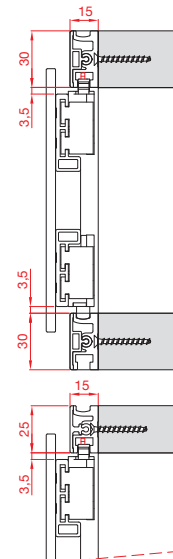

Aluminium door without frame
Anta in alluminio senza cornice

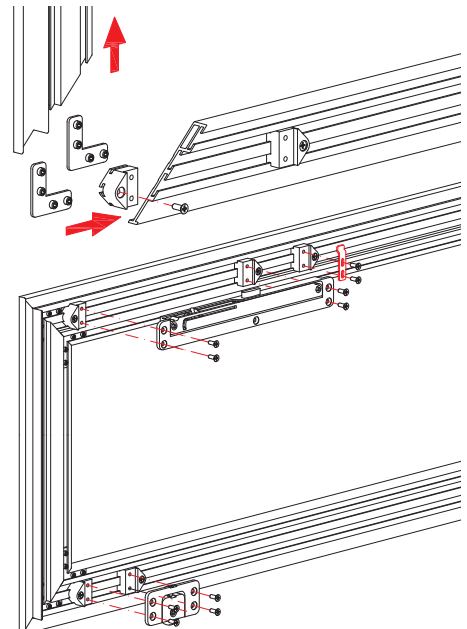

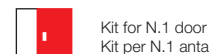
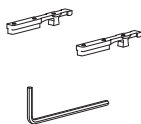
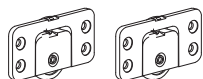
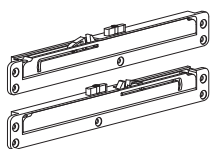

Kit for N.1 door
Kit per N.1 anta





Internal door
Anta interna



Aluminium door
Anta in alluminio



Anodized Nickel
Nichel

OLD CODE	NEW CODE		
2142/2143/T	K.1224.1.16	20 kg	10x
2142/2144/T	K.1224.2.16	40 kg	10x
2142/2149/T	K.1224.3.16	60 kg	10x

MEASUREMENTS DESCRIPTION / DESCRIZIONE MISURE

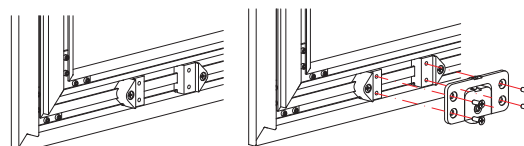
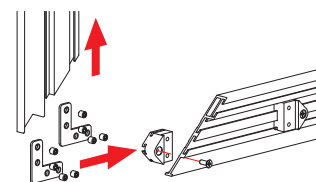
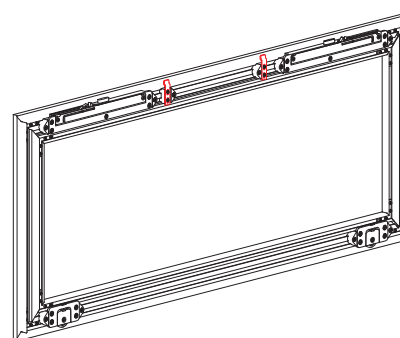
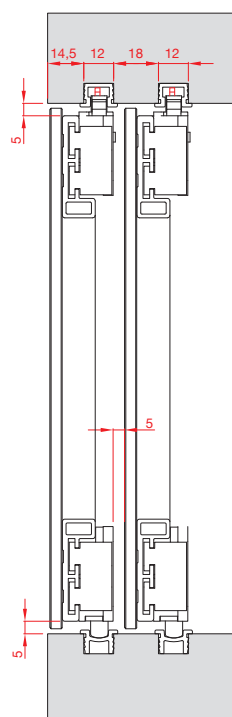
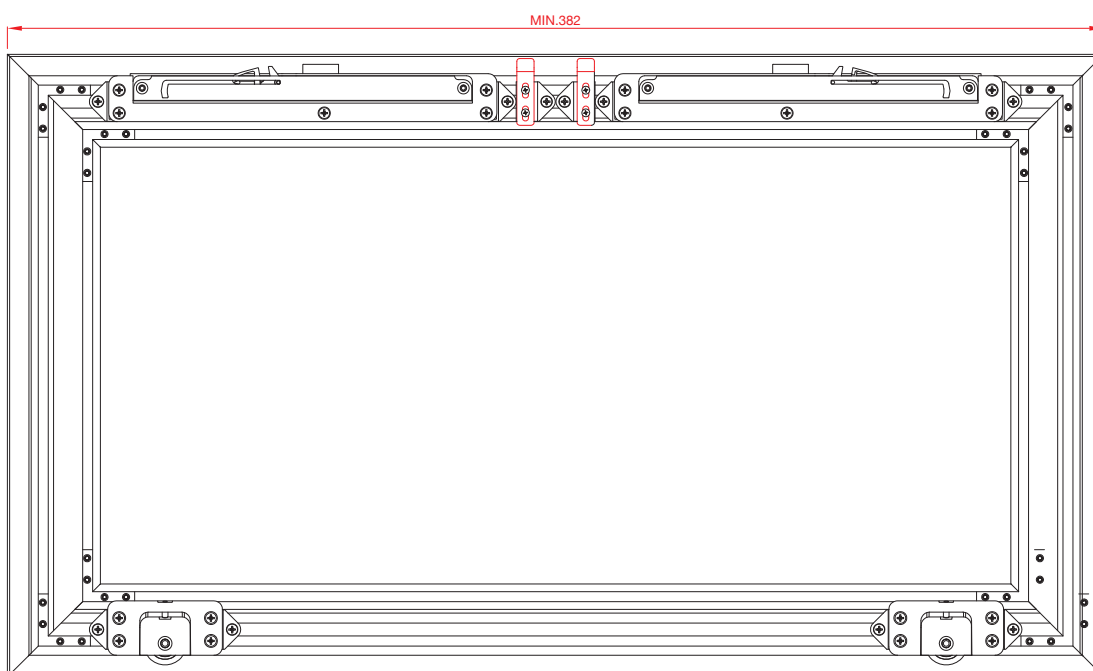



Terno Scorrevoli S.p.A.

**Via Ravenna, 4 - 20814 Varedo (MB) ITALY
Phone +39 0362 543001 - Fax +39 0362 582290**

**terno@ternoscorrevoli.com
www.ternoscorrevoli.com**